

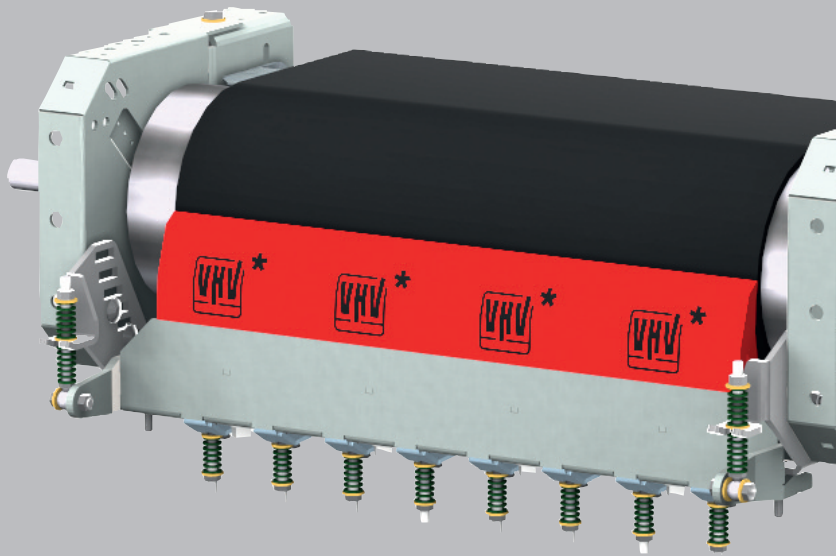

VHV Scraper Systems

Head and Multi-Plate Scraper



With Polyurethane-Blade as a main Scraper

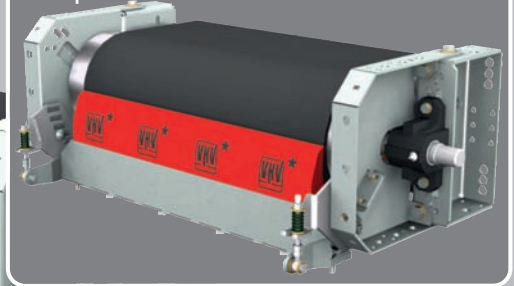

Or with Hard Metal Blades

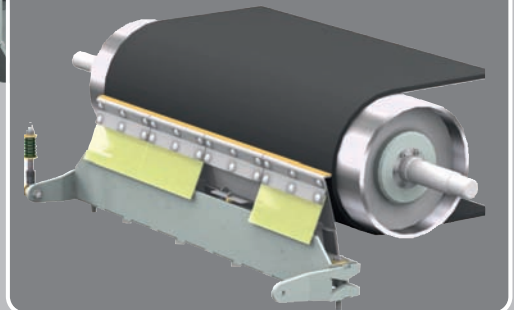

Or in combination Unit
Multi-Plate Scraper in-conjunction
with Pre-scraper

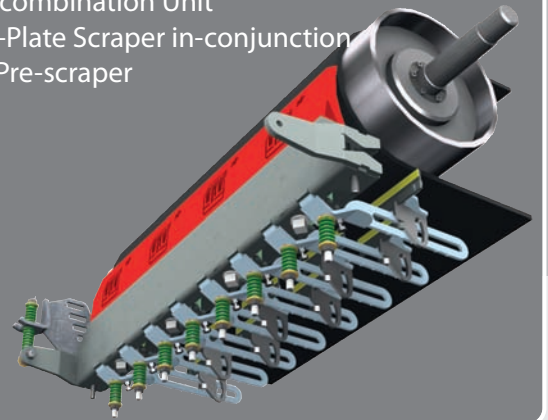

- * Robust and Vibration-Resistant
- * Solid Design
- * Easy to maintain and to install
- * Modular, Exchangeable and Expandable

The VHV Conveyor Head Drum Scraper

The VHV Scraper effectively cleans the belt at the front edge of the discharge pulley below the separation point.

It may be fitted with Polyurethane or with Hard Metal Segments.

A zero stop limits the motion of a worn Scraper.

Scraper can be pneumatically disengaged for use on a reversible Conveyor.

Expandable with VHV Multi-Plate Scraper

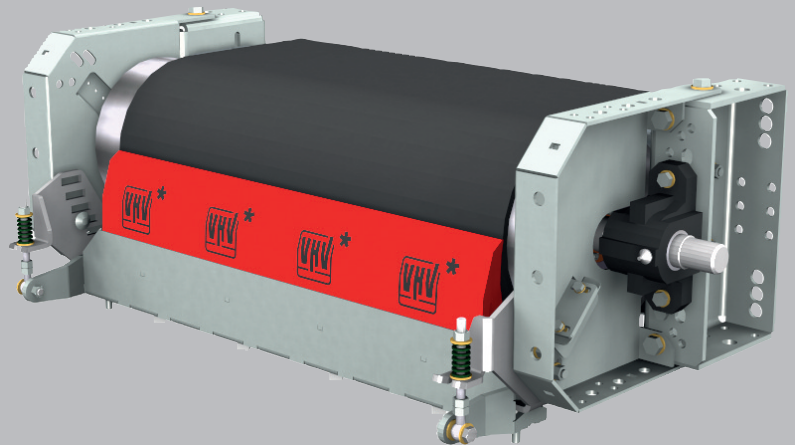

Easy Assembly and Disassembly

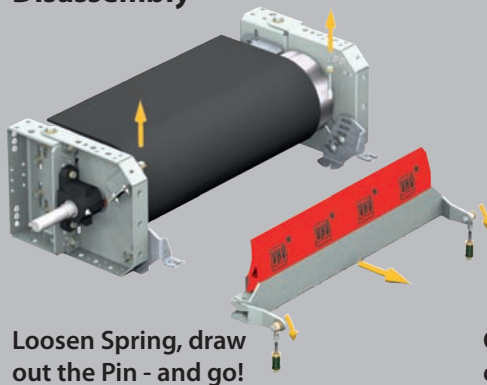

Loosen Spring, draw out the Pin - and go!

Fast change of Segments

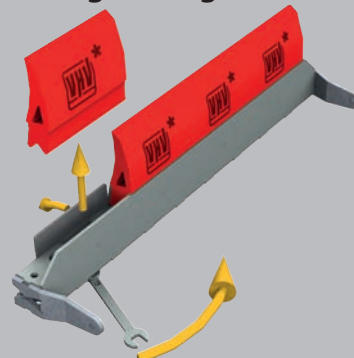

Open Eccentric Turnbuckle, exchange a Blade, release it - Ready!

Hard Metal Segments

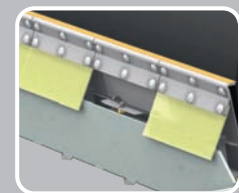

The Highly Wear-Resistant Blades fitted to the Spring Steel Bracket adjust to the Pulley shape. Cleaning Pressure is individually adjustable.

The VHV Multi-Plate Scraper

The offset arrangement of overlapping Scraper Blades clean the belt below the discharge Pulley.

With the advantage to adjust the Angle, Pivot distance and Cleaning pressure of each Scraper Blade, enables individual adjustment.

This enables good cleaning within the Pulley area and the scraped material is removed ahead.

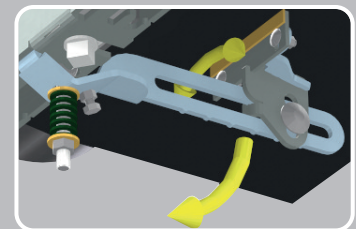
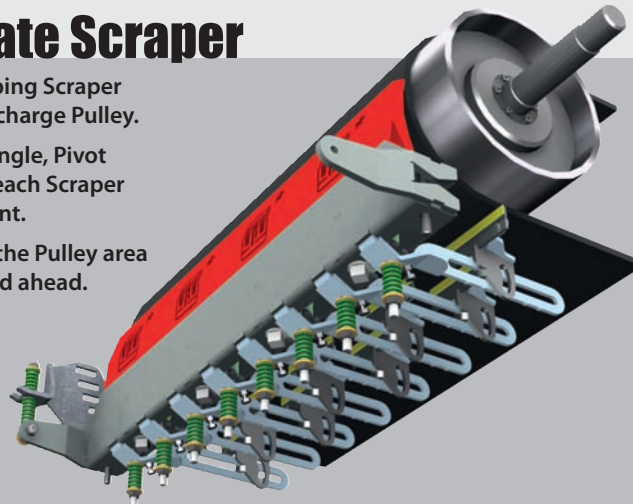

VHV Anlagenbau GmbH

Dornierstraße 9 • D-48477 Hörstel

T +49 5459 9338-0 • F +49 5459 9338-80

Mail: info@vhv-anlagenbau.de • Web: www.vhv-anlagenbau.de